

Remote Control System For Multi Mobile Robot Using A Combination of Computer-Microcontroller

Nanang Ismail

Dept. of Electrical Engineering
SGD State Islamic University
Bandung, Indonesia
nanang.is@uinsgd.ac.id

Okyza, MP

Dept. of Electrical Engineering
SGD State Islamic University
Bandung, Indonesia
okyzaprabowo@gmail.com

Dimas Widyasastrena

Faculty of Engineering & Computer
Science
Indonesia Computer University
Bandung, Indonesia
dimas.widyasastrena@gmail.com

Abstract—Various control systems have been used to optimize robot performance, one of them is to utilize radio wave. The use of radio wave is very common because they are cheap and easy to deploy. Radio frequency use is also various; some use VHF, some others UHF for many purposes. One control system for one robot is definitely inefficient, therefore a continuous research on robot control system is required to control multi robots with different radio frequencies using one control system. This research is meant to develop multiple mobile robots using 40 MHz and 315 MHz frequency within one system controlled by integrated computer and microcontroller. The frequency selection represents VHF and UHF frequency. This research is a prototype for multi robot control. Testing is done with several methods; system interface testing, Line of Sight robot control system, and robot control system in an obscured environment. System interface testing is done by using serial port communication to communicate computer with 8-bit microcontroller using ASCII. Line of Sight testing exerts maximum range of 4 meters using 40 MHz, and 10 meters using 315 MHz. Obscured environment testing exerts maximum range of 2.8 meters for 40 MHz and 13.4 meters for 315 MHz.

Keywords— remote control system; multi mobile robots; microcontroller; Line of Sight; Obstacle

I. Introduction

Robotic development has grown fast. This can be proven by the existence of technology in robotics to assist human activities.

Robot remote control system has been developed in several methods; wireless and wired [1]. Robot data transmission commonly uses serial communication or parallel communication with computers. Typically, wireless control system uses radio frequency [2].

Radio frequency has also been developed for other purposes such as alarm and automatic door system. In a simple manner, data are sent in serial or parallel mode using radio frequency and received by the receiver embedded in the robot to be controlled [3]. In this research, multiple mobile robots using different radio frequencies. Radio frequency use has been shown by Jong Hoon Ahnn using 433 MHz [2] which lies in the Ultra High Frequency (UHF) spectrum and by Walid Wisnu using 45 MHz frequency

[4] which lies in Very High Frequency (VHF). This research focused on using 40 MHz and 315 MHz; 40 MHz is used to control mobile robot from computer or remote control [4] while 315 MHz is used for data communication and electric switches [3].

However, remote control system only developed to control single robot. Thus, we require different control system scheme when dealing with different robots. Using one control system for one robot will cause inefficiency in data transmission particularly when robot motions are only translational; forward, reverse, left, right, and stop [5].

Multiple mobile robots basically have been developed since 1980s [3] but multiple robot control systems have not been specifically developed for instrumentation and control system. Alex Couture-Beil and Richard T. Vanghan [6] research is one of the fundamental multi robot control system research. In this research we will expose control system using general purpose input output in microcontroller as data input and output for mobile robot.

Microcontroller is an electronic IC with the ability of data manipulation based on program instructions [7]. This ability will separate two functions. In this research, microcontroller is used to do switching among controlled robots while computer is used to control robot motions. Therefore, multi robots can be controlled from remote location by computer and microcontroller using without using cable.

II. Design of System

A. Hardware Design

During this stage, control system composed by microcontroller router, 40 MHz and 315 Mhz transmitter, and robot are developed.

Fig. 1. Contains the functional block diagram of this research.

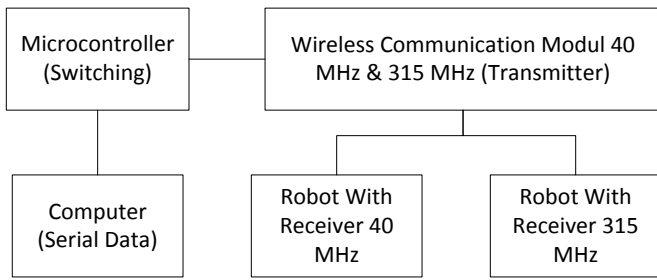

Fig. 1. System block diagram

Microcontroller router has the role as switching to form communication system using 40 MHz and 315 MHz. Transmitter is used to send serial data to robot using 40 MHz and 315 MHz radio wave. The transmitter module is equipped with decoder to communicate data using serial and parallel mode. The receiver module and robot will interpret transmitted data on 40 MHz and 315 MHz. The constructed robot is a simple robot with the ability to do fundamental translational motion forward, reverse, left, right, and stop. Fig.2 and Fig.3 show the constructed robot for this research.

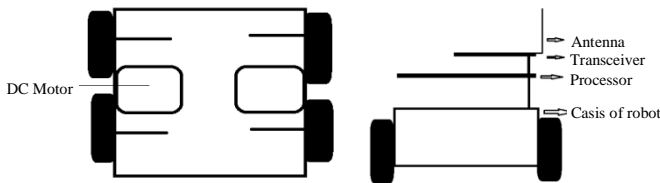

Fig. 2. Top view and front view of robot

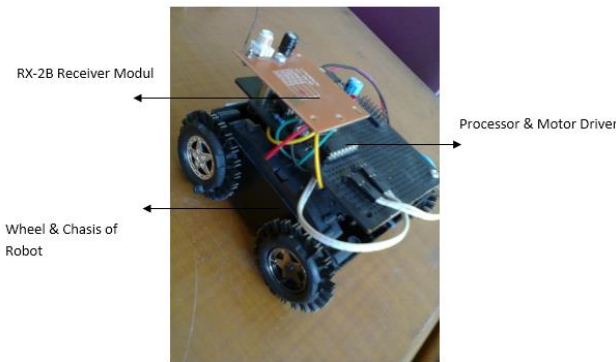

Fig. 3. Mobile robot

B. Software Design

The software for this research consists of applications on computer, router application and robot application. Computer application is a form of Graphical User Interface (GUI) with the function to control robot by giving special instructions via serial port to microcontroller router and display the interaction to the

user. The software for this research uses Java on Netbeans 8.0 IDE. This application name is Multi Robot Control System.

- This application has 2 frames, left frame to control robot motion and right frame to setup microcontroller router
- Right frame has 2 textual menus which change according to numerical input
- Left frame has 4 circles which change according to keyboard input

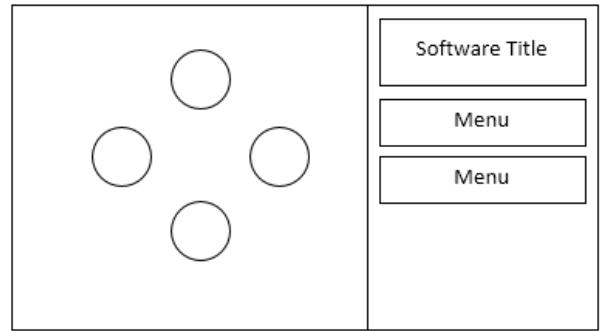

Fig. 4. Multi Robot System Application Design

- Fig. 5 Show the overall software flowchart.

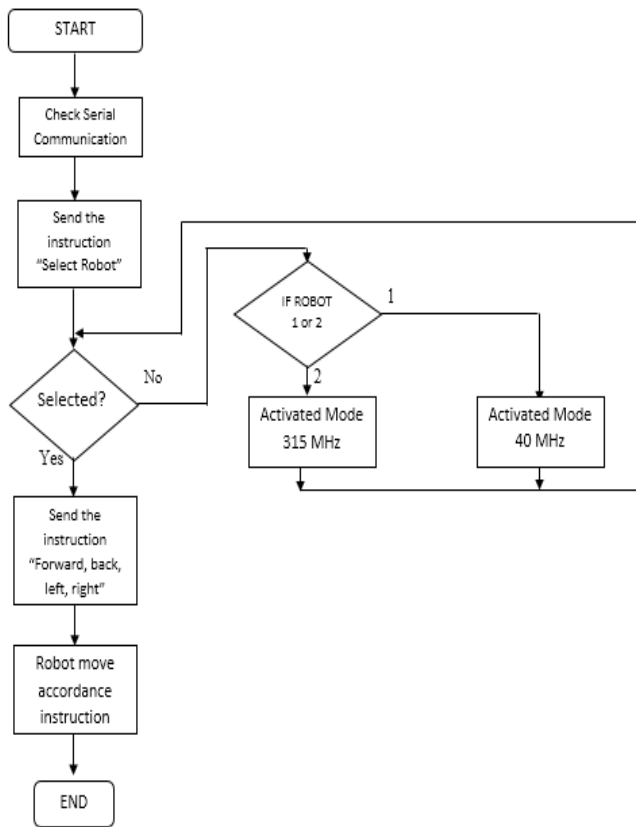

Fig. 5. Software Flowchart

III. System Testing

Testing is done by several actions:

- System interface testing
- Line of Sight wireless communication
- Obscured environment wireless communication system

System testing refers to a scheme such as Fig. 6.

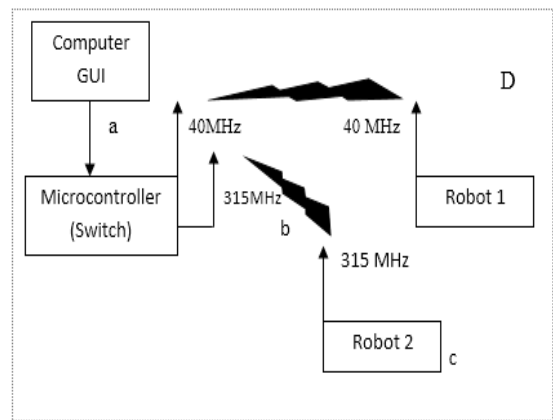

Fig. 6. Scheme of testing

Testing is done with fundamental motions; forward, reverse, left, and right.

A. System Interface Testing

This test is done after microcontroller router and GUI application have been successfully designed. The purpose of this test is to acknowledge the transmitted data whether they run well or not. The method is to send sequential data characters to microcontroller and display them on microcontroller router LCD. LCD is only used to test serial communication of the system. Table I shows the result of the test

TABLE I SERIAL COMMUNICATION TEST RESULT

Character	Remarks	Result
"1"	Mode Robot 1 (Shown on LCD)	Shown
"2"	Mode Robot 2 (Shown on LCD)	Shown
"w"	'ROBOT FORWARD' (Shown on LCD)	Shown
"a"	'ROBOT LEFT' (Shown on LCD)	Shown
"s"	'ROBOT REVERSE' (Shown on LCD)	Shown
"d"	'ROBOT RIGHT' (Shown on LCD)	Shown

B. Line of Sight Testing

Wireless system testing is divided into 2 parts; 40 MHz robot and 315 MHz robot. Testing is done to determine how far the robot control system can be reached in an non-obscured environment (Line of Sight). If in a certain distance the robot can be controlled so the test is a success, fail if otherwise. The test is explained below:

- Internal frequency amplifier within module
- Robot power supply is 6V DC.
- Router adaptor power supply is 9V DC.
- Overall system electric current is 23 mA.

- 5V regulator

Table II and Table III show the wireless testing result on 40 MHz and 315 MHz

TABLE II. 40 MHz ROBOT TEST RESULT

Robot 40 MHz			
Test	Distance	Command	Result
1	1 m	“w” (forward)	OK
2	2 m	“w” (forward)	OK
3	3 m	“w” (forward)	OK
4	4 m	“w” (forward)	OK
5	5 m	“w” (forward)	FAIL

TABLE III. 315 MHz ROBOT TEST RESULT

Robot 315 MHz			
Test	Distance	Command	Result
1	1 m	“w” (forward)	OK
2	2 m	“w” (forward)	OK
3	3 m	“w” (forward)	OK
4	4 m	“w” (forward)	OK
5	5 m	“w” (forward)	OK
6	6 m	“w” (forward)	OK
7	7 m	“w” (forward)	OK
8	8 m	“w” (forward)	OK
9	9 m	“w” (forward)	OK
10	10 m	“w” (forward)	OK

The response difference from 40 MHz and 315 MHz robot occurs because there are energy differences pertaining to frequency. The relation of energy and frequency is shown below:

For 40 MHz,

$$E = h.f$$

$$E = (6,63 \times 10^{-34}) \cdot (40 \times 10^6) = 265,2 \times 10^{-28} \text{ Joule}$$

For 315 MHz,

$$E = h.f$$

$$E = (6,63 \times 10^{-34}) \cdot (315 \times 10^6) = 2088,45 \times 10^{-28} \text{ Joule}$$

From the description above it is evident that 315 MHz has more transmission power over 40 MHz.

C. Testing with Obstacle

This testing is done to test the data quality of the transmitted data in obscured environment. Wireless testing in obscured

environment initially done by locating robot at certain point. Later, send command signals from transmitter to robot initial position

The testing situation is below:

- Using internal frequency amplifier within module
- 6V DC power source for robot
- 9V DC power source for router
- Overall system electric current is 23 mA.
- Obstacle wall thickness is 20 cm
- 5V regulator

Fig 7. Shown sketch of wireless system testing with obstacle.

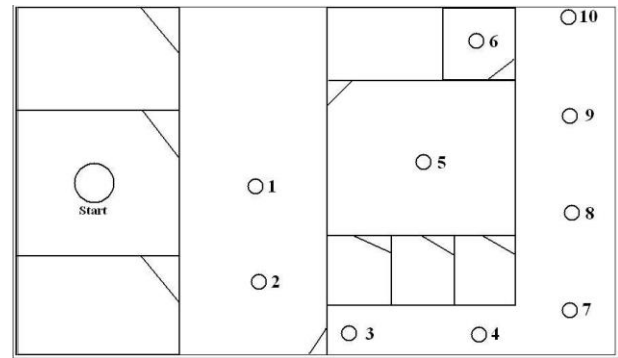

Fig. 7. Obscured Environment Testing Map

Testing with obstacle exerts result as shown in Table IV and Table V

TABLE IV. ROBOT 40 MHz OBSTACLE TEST RESULT

Robot 40 MHz						
Test	Distance	Obstacle 1 distance	Obstacle 2 distance	Obstacle 3 distance	Command	Result
1	2,0 m	1 m	-	-	Reverse	OK
2	3,6 m	1 m	-	-	Reverse	OK
3	5,7 m	1 m	4,3 m	-	Reverse	FAIL

TABLE V. ROBOT 315 MHz OBSTACLE TEST RESULT

Robot 315 MHz						
Test	Distance	Obstacle 1 distance	Obstacle 2 distance	Obstacle 3 distance	Command	Result
1	2,0 m	1 m	-	-	Reverse	OK
2	3,6 m	1 m	-	-	Reverse	OK
3	5,7 m	1 m	4,3 m	-	Reverse	OK
4	7,1 m	1 m	4,3 m	-	Reverse	OK

5	6,2 m	1 m	4,3 m	-	Reverse	OK
6	9,8 m	1 m	4,3 m	7,1 m	Reverse	OK
7	10,0 m	1 m	4,3 m	8,1 m	Reverse	OK
8	12,7 m	1 m	4,3 m	-	Reverse	OK
9	12,8 m	1 m	4,3 m	8,1 m	Reverse	OK
10	13,4 m	1 m	4,3 m	8,1 m	Reverse	OK

- [6] C.B. Alex, Vaughan. R.T, and Mori. G, "Selecting and commanding individual robots in a vision-based multi-robot system," Simon Fraser University Burnaby, B.C., Canada.
- [7] M. Young, *The Technical Writer's Handbook*. Mill Valley, CA: University Science, 1989.

IV. Result

Based on several tests conducted in this research, we conclude:

1) Controlling multiple mobile robot by using 40 MHz and 315 MHz is possible

2) Microcontroller router can receiver 8 bit ASCII code from multi robot system well, switching by transmitting commands to robot using 40 MHz and 315 MHz using general purpose input output

3) Multiple mobile robots can be controlled well by transmitting commands through computer application with the result as following:

a) 40 MHz robot can receive command in LoS environment using general purpose input output with a maximum range of 4 meters.

b) 40 MHz robot can receive command in obscured environment using general purpose input output with a maximum range of 3.6 meters.

c) 315 MHz robot can receive command in LoS environment using general purpose input output with a maximum range of 10 meters.

d) 40 MHz robot can receive command in obscured environment using general purpose input output with a maximum range of 13,4 meters.

ACKNOWLEDGMENT

The authors gratefully acknowledge the contributions of everyone who helps and supports, especially The Dean Faculty of Science & Technology of UIN SGD Bandung.

REFERENCES

- [1] Y. Autret, V. Jean, and L.P. Phillippe, "Transforming basic robotic platforms into easily deployable and web remotely controllable robots," Université Européenne de Bretagne, France, 2008.
- [2] Ahnn. Jong Hoon, "The robot control using wireless communication and serial communcion," Unpublished master of electrical engineering thesis, Cornell University, 2007.
- [3] Alfa, Aloysius, "Utilization of manchester methode for automatic door lock system based on wireless," STIKOM Surabaya.
- [4] W. W. Walid, "Remote controll system of mobil robot using personal computer," Bandung: Computer University. 2011.
- [5] Klavins, Eric. "Communication complexity of multi-robot systems," Pasadena: California Institute of Technology, 2002.